

Parti per YAMATO

Parts for YAMATO



Ditta B. ANICHINI S.r.l.

Via A. Corelli, 67,69,71 - 50127 FIRENZE (ITALIA)

TEL. 055/419845 (RA) - FAX 055/4379249

internet: www.brunoanichini.it

E.MAIL: brunoanichini@tin.it



From the library of: Diamond Needle Corp

Codice	Descrizione	Pagina	Codice	Descrizione	Pagina	Codice	Descrizione	Pagina
1093	Vite	12	2119302	Crochet	9	3208094	Placca	6
110004	Vite	3 ,4, 5, 6	2119303	Crochet	9	3208096	Placca	6
110026	Vite	3	2119305	Crochet	9	3208097	Placca	6
110059	Vite	6	2119322	Crochet	9	3208108	Placca	5
1175	Vite	4, 5	2119323	Crochet	9	3208109	Placca	5
1175	Vite	5	2119324	Crochet	9	3209000	Griffa	4
1222	Vite	7	2121107	Coltello	10	3209001	Griffa	4
1228	Vite	7, 12	2121111	Coltello	10	3209002	Griffa	4
1230	Vite	7	2121235	Coltello	10	3209003	Griffa	4
1230	Vite	12	2129106	Morsetto	12	3209004	Griffa	5
1892	Vite	12	2129300	Crochet	8	3209005	Griffa	5
1900	Vite	12	216	Dado	7	3209006	Griffa	5
2020003	Coltello	10	21700	Crochet	9	3209007	Griffa	5
20271	Coltello	10	21701	Crochet	9	3209008	Griffa	5
20347	Crochet	9	21752	Crochet	9	3209009	Griffa	5
20378	Crochet	9	21754	Crochet	9	3209012	Griffa	6
20462	Griffa	2	21756	Crochet	9	3209013	Griffa	6
20491	Coltello	10	21757	Crochet	9	3209014	Griffa	5
20491/11	Coltello	10	21787	Placca	2	3209016	Griffa	5
20491G	Coltello	10	22195	Coltello	10	3209064	Griffa	5
20496	Coltello	10	22556	Passa filo	13	3209065	Griffa	5
20498	Coltello	10	22893	Placca	2	3209075	Griffa	6
20577	Crochet	8, 9	23465	Passa filo	13	3209080	Griffa	4
2100167	Coltello	10	23580	Coltello	10	3209081	Griffa	4
2100187	Molla	13	23582	Coltello	10	3209100	Morsetto	12
2101091	Coltello	10	24132	Morsetto	12	3209101	Morsetto	12
21033	Crochet	8	24169	Salva ago	13	3209102	Morsetto	12
2108000	Placca	3	24212	Indice	7	3209103	Morsetto	12
2108002	Placca	3	25046	Crochet	9	3209104	Morsetto	12
2108003	Placca	3	26119	Leva	13	3209106	Morsetto	12
2108004	Placca	3	27012	Crochet	9	3209107	Morsetto	12
2108005	Placca	3	27013	Crochet	9	3209108	Morsetto	12
2108006	Placca	3	30255	Molla tensione	13	3209311	Crochet	9
2108050	Placca	3	30421	Coltello	10	32341	Griffa	1
2108052	Placca	3	30421/11	Coltello	10	32358	Passa filo	13
2108076	Placca	3	30619	Linguetta	7	32394	Piedino	7
2109000	Griffa	3	30711	Ingranaggio	13	32415	Crochet	8
2109001	Griffa	3	3100512	Coltello	11	32423	Passa filo	13
2109005	Griffa	3	3100513	Coltello	11	32425	Piastrina	12
2109006	Griffa	3	3101026	Coltello	11	32426	Molla	12
2109007	Griffa	3	3101028	Coltello	11	32539	Crochet	8
2109009	Griffa	3	3101465	Coltello	11	32541	Crochet	8
2109050	Griffa	3	3101607	Coltello	11	32620	Squadretta	13
2109051	Griffa	3	3101633	Coltello	11	32652	Boccola	13
2109052	Griffa	3	3101801	Coltello	11	32653	Boccola	13
2109055	Griffa	3	3101802	Coltello	11	32656	Salva ago	13
2109056	Griffa	3	3106000	Griffa	4	32671	Placca	2
2109067	Griffa	3	3106001	Griffa	4	32672	Placca	2
2109100	Morsetto	12	3108130	Placca	4	32673	Placca	2
2109101	Morsetto	12	3108131	Placca	4	32706	Coltello	10
2109102	Morsetto	12	3108132	Placca	4	32710	Guida	7
2109110	Morsetto	12	3108133	Placca	4	32728	Staffa	13
2109112	Morsetto	12	3108134	Placca	4	32729	Molla	13
2109120	Morsetto	12	3108135	Placca	4	32734	Piedino	7
2109122	Morsetto	12	3109000	Griffa	4	32735	Piedino	7
2109130	Morsetto	12	3109001	Griffa	4	32741	Gambo	7
2109131	Morsetto	12	3109002	Griffa	4	32749	Indice	7
2109132	Morsetto	12	3109003	Griffa	4	32750	Piedino	7
2109183	Morsetto	12	3109017	Griffa	5	32790	Crochet	8
2109187	Morsetto	12	3109018	Griffa	5	32800	Barra crochet	13
2109189	Morsetto	12	3109020	Griffa	5	32807	Crochet	8
2109200	Salva ago	13	3109021	Griffa	5	32813	Crochet	8
2109300	Crochet	8	3109022	Griffa	5	32881	Griffa	2
2109301	Crochet	8	3109300	Crochet	9	32882	Griffa	2
2109302	Crochet	8	3109305	Crochet	9	32883	Griffa	1, 2
2109303	Crochet	8	3109310	Crochet	9	32885	Griffa	2
2109304	Crochet	8	3110037	Coltello	11	32886	Griffa	2
2109305	Crochet	8	3110038	Coltello	11	32912	Collare	13
2109307	Crochet	8	3110038/11	Coltello	11	32914	Coltello	10
2109308	Crochet	8	31111	Disco tensione	13	32917	Ferma coltello	13
2109309	Crochet	8	3118021	Placca	6	32921	Perno	13
2109310	Crochet	8	3118022	Placca	6	32952	Molla tensione	13
2109320	Crochet	8	3118023	Placca	6	32955	Passa filo	13
2109322	Crochet	8	3118024	Placca	6	32959	Passa filo	13
2109324	Crochet	8	3118025	Placca	6	32960	Passa filo	13
2109326	Crochet	8	3118026	Placca	6	32963	Passa filo	13
2109328	Crochet	8	3119020	Griffa	6	32968	Passa filo	13
2109331	Crochet	8	3119021	Griffa	6	32971	Molla tensione	13
2109334	Crochet	8	3120015	Coltello	11	33059	Crochet	8
2109335	Crochet	8	3120016	Coltello	11	33072	Braccio	13
2109341	Crochet	8	3120150	Coltello	11	33074	Perno	13
2109342	Crochet	8	3120151	Coltello	11	33076	Blocchetto	13
2109343	Crochet	8	31877	Crochet	8	33088	Salva ago	13
2109347	Crochet	8	3200046	Passa filo	12	33167	Passa filo	13
2109348	Crochet	8	3200117	Passa filo	12	33203	Passa filo	13
2110305	Coltello	10	3201062	Coltello	11	33205	Guida	13
2111055	Coltello	10	3208025	Placca	5	33247	Morsetto	12
2111056	Coltello	10	3208026	Placca	5	33304	Molla	7
21137	Crochet	9	3208052	Placca	5	33307	Griffa	1
2119301	Crochet	9	3208093	Placca	6	33308	Griffa	1

Codice	Descrizione	Pagina
33328	Griffa	1
33353	Placca	2
33358	Piedino	7
33515	Guida	7
33525	Molla	7
33526	Molla	7
33529	Piastrina	7
33537	Piedino	7
33541	Placca	1
33542	Placca	1
33544	Griffa	1
33545	Placca	1
33549	Griffa	1
33558	Griffa	1
33559	Griffa	1
33751	Guida	13
33814	Griffa	1
33815	Griffa	2
33818	Griffa	1
33824	Griffa	1
33825	Griffa	1
33826	Griffa	1
33827	Griffa	1
33828	Griffa	1
33829	Griffa	1
33830	Griffa	1
33831	Griffa	1
33840	Griffa	1
33841	Griffa	1
33842	Griffa	1
33890	Boccola tensione	13
34113	Crochet	8
34146	Eccentrico	13
34224	Passa filo	13
34392	Crochet	8
34393	Crochet	8
34508	Leva	13
34519	Crochet	8
34535	Coda	7
34539	Crochet	8
34565	Placca	1
34566	Placca	1
34584	Crochet	8
34585	Placca	1
34593	Placca	1
34598	Placca	1
34599	Crochet	8
34600	Placca	1
34604	Placca	1
34616	Crochet	8
34617	Crochet	8
34618	Crochet	8
34619	Crochet	8
34673	Guida	13
34729	Placca	1
34730	Crochet	8
34774	Bottone tensione	13
34858	Passa filo	13
34859	Passa filo	13
34861	Passa filo	13
34914	Morsetto	12
34927	Morsetto	12
34932	Passa filo	13
3501032	Coltello	11
3501200	Coltello	11
3501535	Coltello	11
3508002	Placca	4
3508003	Placca	4
3508004	Placca	4
3508100	Placca	6
3509004	Griffa	4
3509005	Griffa	4
35210	Carter	13
35211	Coltello	10

Codice	Descrizione	Pagina
35227	Crochet	8
35231	Biella	13
35245	Morsetto	12
35253	Crochet	8
35254	Crochet	8
35255	Crochet	8
35259	Griffa	2
35260	Griffa	2
35263	Piedino	7
35264	Griffa	2
35283	Guarnizione	13
35285	Coltello	10
35286	Coltello	10
35287	Crochet	8
35291	Placca	2
35317	Molla	7
35325	Piedino	7
35331	Griffa	2
35334	Placca	2
35335	Griffa	2
35355	Placca	2
35356	Griffa	2
35358	Griffa	2
35359	Griffa	2
35398	Placca	2
35897	Coltello	10
35897/11	Coltello	10
36175	Piastrina	12
36214	Passa filo	13
36233	Passa filo	13
36632	Taglia catenella	13
36923	Piedino	7
37122	Barra ago	12
37301	Crochet	9
37302	Crochet	9
37372	Barra ago	12
37514	Coltello	10
37514/11	Coltello	10
37538	Coltello	10
37538/11	Coltello	10
37635	Scodellino	13
37919	Chiave	12
37966	Guida	13
38011	Morsetto	12
38332	Coltello	10
38332/12	Coltello	10
4353	Vite	1
4353	Vite	2
4406	Vite	2
5036	Vite	7
5345	Vite	3
5401	Vite	1
6093	Vite	7
62	Dado	12
6543	Perno tensione	13
66601	Crochet	9
68121	Coltello	11
68121/11	Coltello	11
68184	Coltello	11
68184/11	Coltello	11
68217	Crochet	9
69084	Crochet	9
69085	Crochet	9
69086	Crochet	9
731	Perno	7
7609	Vite	1, 2
80413	Crochet	9
85168	Crochet	9
9142	Vite	4, 5, 6
93170	Placca	4
93171	Placca	4
93172	Placca	4
93174	Placca	4
93251	Morsetto	12

Codice	Descrizione	Pagina
93252	Morsetto	12
93253	Morsetto	12
93254	Morsetto	12
93255	Morsetto	12
93256	Morsetto	12
93257	Morsetto	12
93258	Morsetto	12
93260	Passa filo	12
93310	Crochet	9
93351	Morsetto	12
93352	Morsetto	12
93353	Morsetto	12
93354	Morsetto	12
93355	Morsetto	12
93356	Morsetto	12
93357	Morsetto	12
93358	Morsetto	12
93365	Passa filo	12
93394	Griffa	4
93395	Griffa	4
93396	Griffa	4
93397	Griffa	4
94210	Placca	5
94211	Placca	5
94212	Placca	5
94214	Placca	5
94230	Griffa	5
94231	Griffa	5
94232	Griffa	5
94233	Griffa	5
94260	Griffa	5
94261	Griffa	5
94262	Griffa	5
94263	Griffa	5
94281	Placca	5
94282	Placca	5
94283	Placca	5
94285	Placca	5
94417	Coltello	11
94480	Crochet	9
94593	Griffa	6
94800	Placca	4
94801	Placca	4
94802	Placca	4
94901	Placca	5
94902	Placca	5
94921	Placca	5
94922	Placca	5
95085	Placca	5
95087	Griffa	5
95174	Crochet	9
95234	Placca	5
95260	Placca	6
95261	Placca	6
95262	Placca	6
95263	Griffa	6
95276	Coltello	11
95277	Coltello	11
95278	Placca	6
95279	Placca	6
95399	Coltello	11
95499	Crochet	9
9730	Vite	1, 2
9986	Dado	7
9987	Perno	7

KI. DCZ300 serie, DCZ500 serie

Vite placca
Needle plate screw
cod. 5401

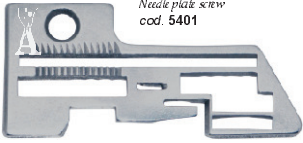

Piedino - Presser foot
cod. 33537

Placca 2 aghi
Needle plate (2 needles)
cod. **33541** (3,2x2 mm)

Vite Screw cod. 4353

Vite Screw cod. 7609



Vite Screw cod. 9730

Griffa principale
Main feed dog
cod. **33825** (8 p.ti x inch)
cod. **33827** (5 p.ti x inch)

Griffa differenziale
Differential feed dog
cod. **33824** (8 p.ti x inch)
[cod. 33826 (5 p.ti x inch)]

Griffa ausiliaria
Auxiliary feed dog
cod. **33544** (8 p.ti x inch)
[cod. 33559 (5 p.ti x inch)]

per arricciatore - ruffler transformation

Griffa principale
Main feed dog
cod. **33308**

Griffa differenziale
Differential feed dog
cod. **33307**

Griffa ausiliaria
Auxiliary feed dog
cod. **33558**

Vite placca
Needle plate screw
cod. 5401



Placca 2 aghi
Needle plate (2 needles)
cod. **33542** (2,4x1 mm)

Vite Screw cod. 4353

Vite Screw cod. 7609

Vite Screw cod. 9730

Griffa principale
Main feed dog
cod. **33825** (8 p.ti x inch)
cod. **33827** (5 p.ti x inch)

Griffa differenziale
Differential feed dog
cod. **33824** (8 p.ti x inch)
[cod. 33826 (5 p.ti x inch)]

Griffa ausiliaria
Auxiliary feed dog
cod. **33544** (8 p.ti x inch)
[cod. 33559 (5 p.ti x inch)]

Vite placca
Needle plate screw
cod. 5401

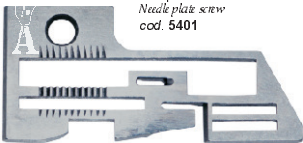

Placca 2 aghi
Needle plate (2 needles)
cod. **33545** (5x3 mm)

Vite Screw cod. 4353

Vite Screw cod. 7609

Vite Screw cod. 9730

Griffa principale
Main feed dog
cod. **33829** (8 p.ti x inch)
cod. **33831** (5 p.ti x inch)

Griffa differenziale
Differential feed dog
cod. **33828** (8 p.ti x inch)
cod. **33830** (5 p.ti x inch)

Griffa ausiliaria
Auxiliary feed dog
cod. **33328** (8 p.ti x inch)
cod. **33549** (5 p.ti x inch)

Vite placca
Needle plate screw
cod. 5401



Placca 1 ago
Needle plate (1 needle)
cod. **34565** D2 (0x2 mm)
cod. **34566** D3 (0x3 mm)

Vite Screw cod. 4353

Vite Screw cod. 7609

Vite Screw cod. 9730

Griffa principale
Main feed dog
cod. **33814** (standard)
cod. **33818** (mat pesanti)
(heavy materials)

Griffa differenziale
Differential feed dog
cod. **33840** (standard)
cod. **33842** (mat pesanti)
(heavy materials)

Griffa ausiliaria
Auxiliary feed dog
cod. **32883**

KI. DCZ300 serie, DCZ500 serie

Vite placca
Needle plate screw
cod. 5401



Placca 2 aghi
Needle plate (2 needles)
cod. **34593**

Vite Screw cod. 4353

Vite Screw cod. 7609

Vite Screw cod. 9730

Griffa principale
Main feed dog
cod. **33814** (standard)
cod. **33818** (mat pesanti)
(heavy materials)

Griffa differenziale
Differential feed dog
cod. **33840** (standard)
cod. **33842** (mat pesanti)
(heavy materials)

Griffa ausiliaria
Auxiliary feed dog
cod. **32883**

Vite placca
Needle plate screw
cod. 5401



Placca 2 aghi
Needle plate (2 needles)
cod. **34585** (= 34598)

Vite Screw cod. 4353

Vite Screw cod. 7609

Vite Screw cod. 9730

Griffa principale
Main feed dog
cod. **33814** (standard)
cod. **33818** (mat pesanti)
(heavy materials)

Griffa differenziale
Differential feed dog
cod. **33840** (standard)
cod. **33842** (mat pesanti)
(heavy materials)

Griffa ausiliaria
Auxiliary feed dog
cod. **32883**

Vite placca
Needle plate screw
cod. 5401

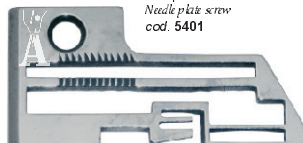

Placca 2 aghi
Needle plate (2 needles)
cod. **34604** (= 34600)

Vite Screw cod. 4353

Vite Screw cod. 7609

Vite Screw cod. 9730

Griffa principale
Main feed dog
cod. **33814** (standard)
cod. **33818** (mat pesanti)
(heavy materials)

Griffa differenziale
Differential feed dog
cod. **33840** (standard)
cod. **33842** (mat pesanti)
(heavy materials)

Griffa ausiliaria
Auxiliary feed dog
cod. **32341**

Vite placca
Needle plate screw
cod. 5401



Placca 2 aghi
Needle plate (2 needles)
cod. **34729**

Vite Screw cod. 4353

Vite Screw cod. 7609

Vite Screw cod. 9730

Griffa principale
Main feed dog
cod. **33814** (standard)

Griffa differenziale
Differential feed dog
cod. **33841** (standard)

Griffa ausiliaria
Auxiliary feed dog
cod. **32341**

From the library of: Diamond Needle Corp

KI. DCZ341, Z600 serie

Vite placca
Needle plate screw
cod. 4406



Placca 2 aghi
Needle plate (2 needles)
cod. **35291 D4**

Piedino - Presser foot
cod. 35263

Vite
Screw
cod. 4353

Vite
Screw
cod. 7609

Vite
Screw
cod. 9730

Griffa principale
Main feed dog
cod. **35260**

Griffa differenziale
Differential feed dog
cod. **35259**

Griffa ausiliaria
Auxiliary feed dog
cod. **35264**

Vite placca
Needle plate screw
cod. 4406



Placca 2 aghi
Needle plate (2 needles)
cod. **35334 D4**

Piedino - Presser foot
cod. 35263

Vite
Screw
cod. 4353

Vite
Screw
cod. 7609

Vite
Screw
cod. 9730

Griffa principale
Main feed dog
cod. **35331**

Griffa differenziale
Differential feed dog
cod. **35335**

Griffa ausiliaria
Auxiliary feed dog
cod. **35264**

Vite placca
Needle plate screw
cod. 4406



Placca 2 aghi
Needle plate (2 needles)
cod. **35355 D4**

Vite
Screw
cod. 4353

Vite
Screw
cod. 7609

Vite
Screw
cod. 9730

Griffa principale
Main feed dog
cod. **35356**

Griffa differenziale
Differential feed dog
cod. **35335**

Griffa ausiliaria
Auxiliary feed dog
cod. **35264**

Vite placca
Needle plate screw
cod. 4406



Placca 2 aghi
Needle plate (2 needles)
cod. **35398 C5**

Vite
Screw
cod. 4353

Vite
Screw
cod. 7609

Vite
Screw
cod. 9730

Griffa principale
Main feed dog
cod. **35359**

Griffa differenziale
Differential feed dog
cod. **35358**

Griffa ausiliaria
Auxiliary feed dog
cod. **35264**

KI. Z5000 serie

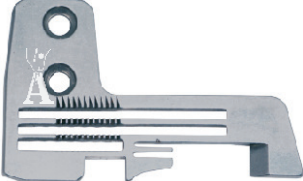

Placca 2 aghi
Needle plate (2 needles)
cod. **21787**



Placca 2 aghi
Needle plate (2 needles)
cod. **22893**

KI. DCZ203, 220

Vite placca
Needle plate screw
cod. 5401



Placca 1 ago
Needle plate (1 needle)
cod. **32671 D1** (2,5 mm)
cod. **32672 D2** (3,5 mm)
cod. **32673 D3** (4,5 mm)

Vite
Screw
cod. 4353

Vite
Screw
cod. 7609

Vite
Screw
cod. 9730

Griffa principale
Main feed dog
cod. **32882** (standard)
cod. **32886** (mat pesanti)
(heavy materials)

Griffa differenziale
Differential feed dog
cod. **32881** (standard)
cod. **32885** (mat pesanti)
(heavy materials)

Griffa ausiliaria
Auxiliary feed dog
cod. **32883**

Vite placca
Needle plate screw
cod. 5401



Placca 2 aghi
Needle plate (2 needles)
cod. **33353**

Vite
Screw
cod. 4353

Vite
Screw
cod. 7609

Vite
Screw
cod. 9730

Griffa principale
Main feed dog
cod. **32882** (standard)
cod. **32886** (mat pesanti)
(heavy materials)

Griffa differenziale
Differential feed dog
cod. **32881** (standard)
cod. **32885** (mat pesanti)
(heavy materials)

Griffa ausiliaria
Auxiliary feed dog
cod. **32883**

KI. DCZ200, 220, 224



Griffa differenziale
Differential feed dog
cod. **33815**

KI. Z6000



Griffa ausiliaria
Auxiliary feed dog
cod. **20462**

KI. AZ6000 serie, AZ8000 serie

Vite placca
Needle plate screw
cod. 5345



Placca 1 ago
Needle plate (1 needle)
cod. **2108000** (4 mm)

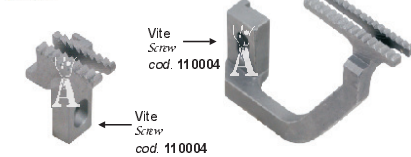

Griffa principale
Main feed dog
cod. **2109001**

Griffa differenziale
Differential feed dog
cod. **2109000**

Griffa ausiliaria
Auxiliary feed dog
cod. **2109067**

KI. AZ6000 serie, AZ8000 serie

Vite placca
Needle plate screw
cod. 5345



Placca 2 aghi
Needle plate (2 needles)
cod. **2108005** (2,4x6 mm)

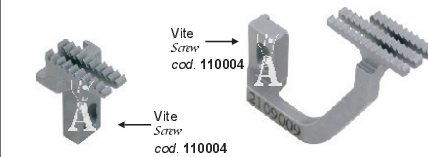

Griffa principale
Main feed dog
cod. **2109006**

Griffa differenziale
Differential feed dog
cod. **2109009**

Griffa ausiliaria
Auxiliary feed dog
cod. **2109067**

Vite placca
Needle plate screw
cod. 5345

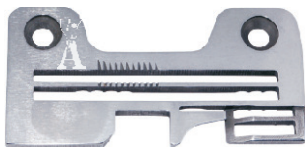

Placca 1 ago
Needle plate (1 needle)
cod. **2108002** (3 mm)



Griffa principale
Main feed dog
cod. **2109006**

Griffa differenziale
Differential feed dog
cod. **2109007**

Griffa ausiliaria
Auxiliary feed dog
cod. **2109067**

Vite placca
Needle plate screw
cod. 5345



Placca 2 aghi
Needle plate (2 needles)
cod. **2108006** (2,0x4 mm)

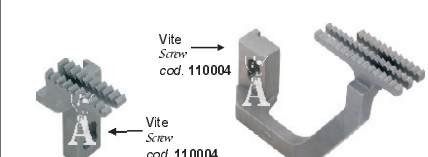

Griffa principale
Main feed dog
cod. **2109006**

Griffa differenziale
Differential feed dog
cod. **2109005**

Griffa ausiliaria
Auxiliary feed dog
cod. **2109067**

KI. AZ6500 serie, AZ8500 serie

Vite placca
Needle plate screw
cod. 5345



Placca 2 aghi
Needle plate (2 needles)
cod. **2108050** (3,2x4 mm)

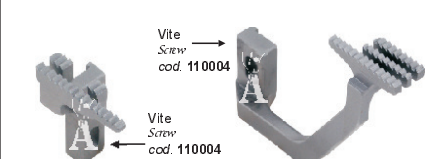

Griffa principale
Main feed dog
cod. **2109051**

Griffa differenziale
Differential feed dog
cod. **2109050**

Griffa ausiliaria
Auxiliary feed dog
cod. **2109052**

Vite placca
Needle plate screw
cod. 5345



Placca 1 ago
Needle plate (1 needle)
cod. **2108003** (4 mm)



Griffa principale
Main feed dog
cod. **2109006**

Griffa differenziale
Differential feed dog
cod. **2109005**

Griffa ausiliaria
Auxiliary feed dog
cod. **2109067**

Vite placca
Needle plate screw
cod. 5345



Placca 2 aghi
Needle plate (2 needles)
cod. **2108076** (5x5 mm)
(= 2108052)

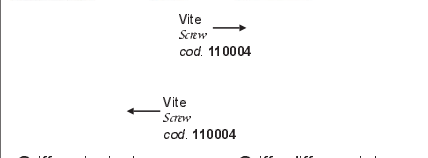

Griffa principale
Main feed dog
cod. **2109056**

Griffa differenziale
Differential feed dog
cod. **2109055**

Griffa ausiliaria
Auxiliary feed dog
cod. **2109052**

**KI. DV1400, DW1500, VF 1400, VF1500,
VF2400, VF2500, VF2530,
VC2600, VC2700, VC2730**

Placche e griffe per cuciture normali
Needle plates and feed dogs for plain seaming operations

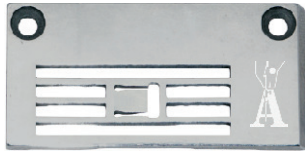

Vite placca
Needle plate screw
cod. 9142

Placca 2 aghi
Needle plate (2 needles)
cod. **93170** (3,2 mm)
cod. **93171** (4,0 mm)
cod. **93172** (4,8 mm)
cod. **93174** (6,4 mm)



Vite placca
Needle plate screw
cod. 9142

Placca 3 aghi
Needle plate (3 needles)
cod. **94800** (4,8 mm)
cod. **94801** (5,6 mm)
cod. **94802** (6,4 mm)

(MACCHINE PIANE - FLAT BED MACHINES)
KI. DV1400, DW1500, VF1400, VF1500



Vite griffa
Feed dog screw
cod. 1175

Griffa principale
Main feed dog
cod. **93395** (3,2 - 5,6 mm)
cod. **93397** (6,4 mm)



Vite griffa
Feed dog screw
cod. 1175

Griffa differenziale
Differential feed dog
cod. **93394** (3,2 - 5,6 mm)
cod. **93396** (6,4 mm)

(MACCHINE PIANE - FLAT BED MACHINES)
KI. VF2200, VF2300



Griffa principale
Main feed dog
cod. **3209080** (3,2 - 5,6 mm)
cod. **3209081** (6,4 mm)

Vite griffe
Feed dog screw
cod. 110004



Griffa differenziale
Differential feed dog
cod. **3209001** (3,2 - 5,6 mm)
cod. **3209003** (6,4 mm)

(MACCHINE PIANE - FLAT BED MACHINES)
KI. VF2400, VF2500, VF2530



Griffa principale
Main feed dog
cod. **3209000** (3,2 - 5,6 mm)
cod. **3209002** (6,4 mm)

Vite griffe
Feed dog screw
cod. 110004

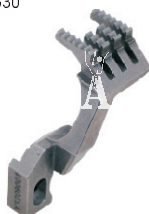

Griffa differenziale
Differential feed dog
cod. **3209001** (3,2 - 5,6 mm)
cod. **3209003** (6,4 mm)

(MACCHINE A BRACCIO - FREE ARM MACHINES)
KI. VC2600, VC2700, VC2730

Griffa principale
Main feed dog
cod. **3109001** (3,2 - 5,6 mm)
cod. **3109003** (6,4 mm)

Vite griffe
Feed dog screw
cod. 110004

Griffa differenziale
Differential feed dog
cod. **3109000** (3,2 - 5,6 mm)
cod. **3109002** (6,4 mm)

**KI. VF2200, VF2300, VFU2500,
VCU2700, VCU2730**

Placche e griffe per cuciture normali
Needle plates and feed dogs for plain seaming operations



Vite placca
Needle plate screw
cod. 9142

Placca 2 aghi
Needle plate (2 needles)
cod. **3108130** (3,2 mm)
cod. **3108131** (4,0 mm)
cod. **3108132** (4,8 mm)

(MACCHINE PIANE - FLAT BED MACHINES)
KI. VF2200, VF2300, VFU2500



Griffa principale
Main feed dog
cod. **3209080** (3,2 - 5,6 mm)
cod. **3209081** (6,4 mm)

Vite griffe
Feed dog screw
cod. 110004



Griffa differenziale
Differential feed dog
cod. **3209001** (3,2 - 5,6 mm)
cod. **3209003** (6,4 mm)

(MACCHINE A BRACCIO - FREE ARM MACHINES)
KI. VCU2700, VCU2730

Griffa principale
Main feed dog
cod. **3106000** (3,2 - 5,6 mm)
cod. **3106001** (6,4 mm)

Vite griffe
Feed dog screw
cod. 110004

Griffa differenziale
Differential feed dog
cod. **3109000** (3,2 - 5,6 mm)
cod. **3109002** (6,4 mm)

KI. VG2700

Placche e griffe per cuciture normali
Needle plates and feed dogs for plain seaming operations



Vite placca
Needle plate screw
cod. 9142

Placca 3 aghi
Needle plate (3 needles)
cod. **3508002** (4,8 mm)
cod. **3508003** (5,6 mm)
cod. **3508004** (6,4 mm)



Griffa principale
Main feed dog
cod. **3509005**

Vite griffe
Feed dog screw
cod. 110004

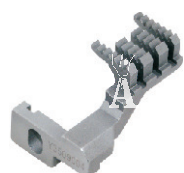

Griffa differenziale
Differential feed dog
cod. **3509004**

KI. DV1403, DW1503, VF2403, VF2503, VC2600, VC2700

Placche e griffe per bordare Needle plates and feed dogs for binding tape operations

(MACCHINE PIANE - FLAT BED MACHINES)
KI. DV1403, DW1503



Vite placca
Needle plate screw
cod. 9142

Placca 2 aghi
Needle plate (2 needles)
cod. **94281** (3,2 mm)
cod. **94282** (4,0 mm)
cod. **94283** (4,8 mm)
cod. **94285** (6,4 mm)

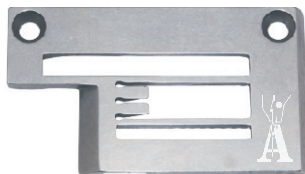

Vite placca
Needle plate screw
cod. 9142

Placca 3 aghi
Needle plate (3 needles)
cod. **94921** (5,6 mm)
cod. **94922** (6,4 mm)

(MACCHINE PIANE - FLAT BED MACHINES)
KI. DV1403, DW1503

Vite griffa
Feed dog screw
cod. 1175

Vite griffa
Feed dog screw
cod. 1175



Griffa principale
Main feed dog
cod. **94261** (3,2 - 5,6 mm)
cod. **94263** (6,4 mm)

Griffa differenziale
Differential feed dog
cod. **94260** (3,2 - 5,6 mm)
cod. **94262** (6,4 mm)

(MACCHINE PIANE - FLAT BED MACHINES)
KI. VF2403, VF2503, VF2603, VF2703



Vite placca
Needle plate screw
cod. 9142

Placca 2 aghi
Needle plate (2 needles)
cod. **94210** (3,2 mm)
cod. **94211** (4,0 mm)
cod. **94212** (4,8 mm)
cod. **94214** (6,4 mm)

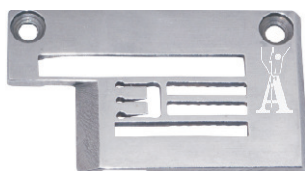

Vite placca
Needle plate screw
cod. 9142

Placca 3 aghi
Needle plate (3 needles)
cod. **3208026** (4,8 mm)
cod. **94901** (5,6 mm)
cod. **94902** (6,4 mm)

(MACCHINE PIANE - FLAT BED MACHINES)
KI. VF2403, VF2503

Vite griffa
Feed dog screw
cod. 1175

Vite griffa
Feed dog screw
cod. 1175

Griffa principale
Main feed dog
cod. **3209014** (3,2 - 5,6 mm)
(= 3209004) (= 94231)
cod. **3209016** (6,4 mm)
(= 3209006) (= 94233)

Griffa differenziale
Differential feed dog
cod. **3209005** (3,2 - 5,6 mm)
(= 94230)
cod. **3209007** (6,4 mm)
(= 94232)

(MACCHINE A BRACCIO - FREE ARM MACHINES)
KI. VF2603, VF2703

Vite griffa
Feed dog screw
cod. 110004

Vite griffa
Feed dog screw
cod. 110004

Griffa principale
Main feed dog
cod. **3109018** (3,2 - 5,6 mm)
cod. **3109021** (6,4 mm)

Griffa differenziale
Differential feed dog
cod. **3109017** (3,2 - 5,6 mm)
cod. **3109022** (6,4 mm)

KI. VF1403-11, VF1503-11, VF2403-11, VF2503-11, VF2504-11, VC2603-11, VC2703-11

Placche e griffe per bordare Needle plates and feed dogs for binding tape operations

Vite placca
Needle plate screw
cod. 9142

Placca 2 aghi
Needle plate (2 needles)
cod. **95234** (4,0 mm)



Vite placca
Needle plate screw
cod. 9142

Placca 3 aghi
Needle plate (3 needles)
cod. **3208052** (4,8 mm)
cod. **95085** (5,6 mm)
cod. **3008025** (6,4 mm)

(MACCHINE PIANE - FLAT BED MACHINES)
KI. VF1403-11, VF1503-11

Vite griffa
Feed dog screw
cod. 1175

Vite griffa
Feed dog screw
cod. 1175

Griffa principale
Main feed dog
cod. **3209016** (6,4 mm)
(= 3209006) (= 94233)

Griffa differenziale
Differential feed dog
cod. **95087**

(MACCHINE PIANE - FLAT BED MACHINES)
KI. VF2403-11, VF2503-11, VF2504-11

Vite griffa
Feed dog screw
cod. 110004

Vite griffa
Feed dog screw
cod. 110004

Griffa principale
Main feed dog
cod. **3209008**

Griffa differenziale
Differential feed dog
cod. **3209009**

(MACCHINE A BRACCIO - FREE ARM MACHINES)
KI. VC2603-11, VC2703-11

Vite griffa
Feed dog screw
cod. 110004

Vite griffa
Feed dog screw
cod. 110004

Griffa principale
Main feed dog
cod. **3109021**

Griffa differenziale
Differential feed dog
cod. **3109020**

KI. VF2303-21, VF2503-21

Placche e griffe per bordare Needle plates and feed dogs for binding tape operations

Vite placca
Needle plate screw
cod. 9142

Placca 3 aghi
Needle plate (3 needles)
cod. **3208108** (5,6 mm)
cod. **3208109** (6,4 mm)



Vite griffa
Feed dog screw
cod. 110004

Vite griffa
Feed dog screw
cod. 110004

Griffa principale
Main feed dog
cod. **3209064**

Griffa differenziale
Differential feed dog
cod. **3209065**

**KI. DV1409, DW1509, VF1409, VF1509
VF2429G, VF2529G**

Placche e griffe per meccanismo rifilatore
Needle plates and feed dogs for fabric trimmer mechanism

(MACCHINE PIANE - FLAT BED MACHINES)
KI. DV1409, DW1509, VF1409, VF1509



Vite placca
Needle plate screw
cod. 9142

Placca 2 aghi
Needle plate (2 needles)
cod. **95260** (3,2 mm)
cod. **95261** (4,0 mm)
cod. **95262** (4,8 mm)

Vite placca
Needle plate screw
cod. 9142

Placca 3 aghi
Needle plate (3 needles)
cod. **95278** (5,6 mm)
cod. **95279** (6,4 mm)

(MACCHINE PIANE - FLAT BED MACHINES)
KI. DV1409, DW1509, VF1409, VF1509

Vite griffa
Feed dog screw
cod. 1175

Vite griffa
Feed dog screw
cod. 1175

Griffa principale
Main feed dog
cod. **94593**

Griffa differenziale
Differential feed dog
cod. **95263**

(MACCHINE PIANE - FLAT BED MACHINES)
KI. VF2429G, VF2529G

Vite griffa
Feed dog screw
cod. 110004

Vite griffa
Feed dog screw
cod. 110004



Griffa principale
Main feed dog
cod. **3209012**

Griffa differenziale
Differential feed dog
cod. **3209013**

KI. VF2439-1, VF2539-1

Placche e griffe per meccanismo rifilatore
Needle plates and feed dogs for fabric trimmer mechanism



Vite placca
Needle plate screw
cod. 9142

Placca 2 aghi
Needle plate (2 needles)
cod. **3208097** (3,2 mm)
cod. **3208096** (4,0 mm)



Vite placca
Needle plate screw
cod. 9142

Placca 3 aghi
Needle plate (3 needles)
cod. **3208093** (5,6 mm)
cod. **3208094** (6,4 mm)

Vite griffa
Feed dog screw
cod. 110004

Vite griffa
Feed dog screw
cod. 110004



Griffa principale
Main feed dog
cod. **3209075**

Griffa differenziale
Differential feed dog
cod. **3209013**

KI. VC3611-D, VC3711-D, VCU3711

Placche e griffe per meccanismo rifilatore
Needle plates and feed dogs for fabric trimmer mechanism

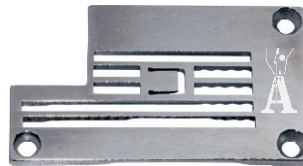

Vite placca
Needle plate screws
cod. 9142
cod. 110059

Placca 2 aghi
Needle plate (2 needles)
cod. **3118021** (4,0 mm)
cod. **3118022** (4,8 mm)
cod. **3118023** (5,6 mm)

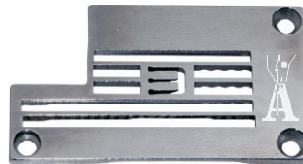

Vite placca
Needle plate screws
cod. 9142
cod. 110059

Placca 3 aghi
Needle plate (3 needles)
cod. **3118024** (4,8 mm)
cod. **3118025** (5,6 mm)
cod. **3118026** (6,4 mm)

Vite griffa
Feed dog screw
cod. 110004

Vite griffa
Feed dog screw
cod. 110004

Griffa principale
Main feed dog
cod. **3119021**

Griffa differenziale
Differential feed dog
cod. **3119020**

KI. VG3721

Placche e griffe per meccanismo rifilatore
Needle plates and feed dogs for fabric trimmer mechanism

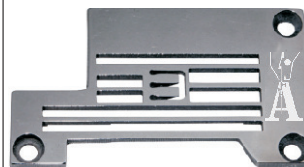

Vite placca
Needle plate screws
cod. 9142
cod. 110059

Placca 3 aghi
Needle plate (3 needles)
cod. **3508100** (5,6 mm)

KI. DCZ300 serie

KI. DCZ-361-D1,D2

KI. DCZ-341-C

KI. DCZ-341-C-1

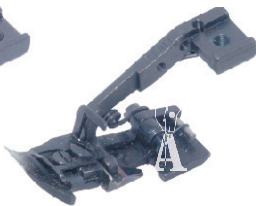
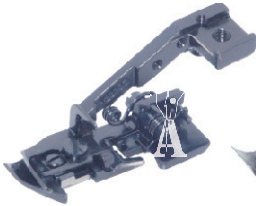

Piedino 2 aghi
Presser foot (2 needles)
cod. **33537** (3,2x2 mm)

Piedino 2 aghi
Presser foot (2 needles)
cod. **35263** (5x4 mm)

Piedino 2 aghi
Presser foot (2 needles)
cod. **35325** (5x4 mm)

KI. DCZ500 serie

KI. DCZ-500-D1,D2,D3

KI. DCZ-520-D1, DCZ-554-D1-1

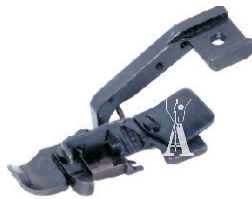
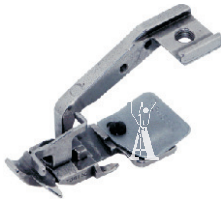

Piedino 1 ago
Presser foot (1 needle)
cod. **32734** (2-3 mm)
cod. **32735** (1 mm)

Piedino 2 aghi
Presser foot (2 needles)
cod. **32750**

KI. DCZ-503-D4

KI. DCZ-546-D1, DCZ-547-D1

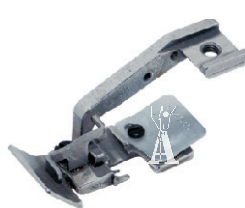
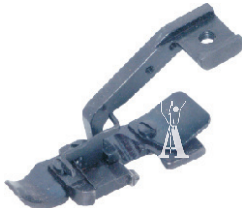

Piedino 1 ago
Presser foot (1 needle)
cod. **32394** (4 mm)

Piedino 2 aghi
per arricciatore
Presser foot (2 needles)
for ruffler attachment
cod. **33358** (= 36923)

KI.

KI. DCZ300 serie, DCZ500 serie

Ricambi per piedini - Presser feet's spare parts

KI. DCZ-300, DCZ-341-C

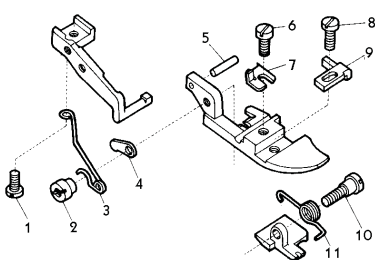

KI. DCZ-341-C-1

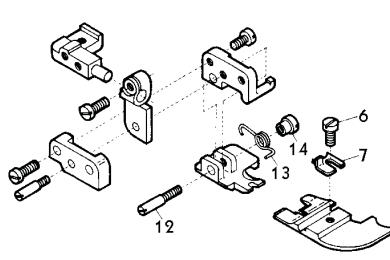

KI. DCZ-500

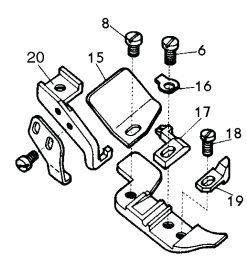

- | | | | | | | | | | | |
|---|--|--|---|---|---|--|---|---|--|---|
| 1
Vite
Screw
cod. 1222 | 2
Dado
Nut
cod. 216 | 3
Molla
Spring
cod. 33525 | 4
Piastrina
Plate
cod. 33529 | 5
Perno
Pin
cod. 731 | 6
Vite
Screw
cod. 5036 | 7
Molla
Spring
cod. 33304 | 8
Vite
Screw
cod. 1228 | 9
Guida
Guide
cod. 33515 | 10
Vite
Screw
cod. 6093 | 11
Molla
Spring
cod. 33526 |
|---|--|--|---|---|---|--|---|---|--|---|

- | | | | | | | | | | |
|---|---|--|--|--|---|---|--|--|--|
| 12
Perno
Pin
cod. 9987 | 13
Molla
Spring
cod. 35317 | 14
Dado
Nut
cod. 9986 | 15
Coda
Shoe
cod. 34535 | 16
Fermo
Stopper
cod. 30619 | 17
Indice
Stitch tongue
cod. 24212 | 17
Indice
Stitch tongue
cod. 32749 | 18
Vite
Screw
cod. 1230 | 19
Guida
Guide
cod. 32710 | 20
Gambo
Foot holder
cod. 32741 |
|---|---|--|--|--|---|---|--|--|--|

KI. DCZ300 serie, DCZ500 serie, Z610, Z612



Crochet sup. Upper looper cod. **32807**
 Crochet sup. Upper looper cod. **32813**
 Crochet sup. Upper looper cod. **34519**
 Crochet sup. Upper looper cod. **34539**



Crochet sup. Upper looper cod. **34584**
 Crochet sup. Upper looper cod. **34599**
 Crochet sup. Upper looper cod. **34617**
 Crochet sup. Upper looper cod. **34618**



Crochet sup. Upper looper cod. **34730**
 (= 34599)
 Crochet sup. Upper looper cod. **35227**
 (= 32599)
 Crochet sup. Upper looper cod. **35253**
 Crochet sup. Upper looper cod. **35287**



Crochet sup. Upper looper cod. **21033**
 Crochet sup. Upper looper cod. **34113**

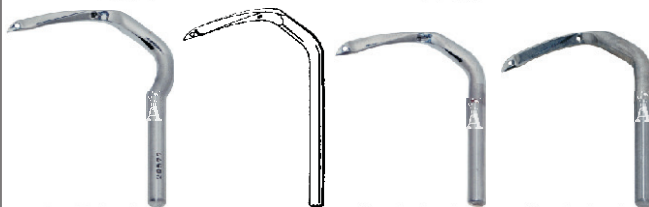

Crochet cat. Chain looper cod. **20577**
 Crochet cat. Chain looper cod. **31877**
 Crochet cat. Chain looper cod. **33059**
 Crochet cat. Chain looper cod. **35255**



Crochet inf. Lower looper cod. **32541**
 Crochet inf. Lower looper cod. **34392**
 (= 32790)
 Crochet inf. Lower looper cod. **34393**
 (= 32415)



Crochet inf. Lower looper cod. **34616**
 Crochet inf. Lower looper cod. **34619**
 Crochet inf. Lower looper cod. **35254**

KI. AZ6000, 6500, 8000, 8500, 8600 serie



Crochet sup. Upper looper cod. **2109301**
 Crochet sup. Upper looper cod. **2109303**
 Crochet sup. Upper looper cod. **2109304**
 Crochet sup. Upper looper cod. **2109305**



Crochet sup. Upper looper cod. **2109307**
 Crochet sup. Upper looper cod. **2109309**
 Crochet sup. Upper looper cod. **2109310**
 Crochet sup. Upper looper cod. **2109320**



Crochet sup. Upper looper cod. **2109322**
 Crochet sup. Upper looper cod. **2109324**
 Crochet sup. Upper looper cod. **2109326**
 Crochet sup. Upper looper cod. **2109328**



Crochet sup. Upper looper cod. **2109341**
 Crochet sup. Upper looper cod. **2109342**
 Crochet sup. Upper looper cod. **2109343**
 Crochet sup. Upper looper cod. **2129300**



Crochet inf. Lower looper cod. **2109300**
 Crochet inf. Lower looper cod. **2109308**
 Crochet inf. Lower looper cod. **2109331**



Crochet inf. Lower looper cod. **2109334**
 Crochet inf. Lower looper cod. **2109347**
 Crochet inf. Lower looper cod. **2109348**



Crochet cat. Chain looper cod. **2109302**
 Crochet cat. Chain looper cod. **2109335**

KI. Z3000 serie, Z5000 serie, Z6000 serie



Crochet sup.
Upper looper
cod. **21700**

Crochet sup.
Upper looper
cod. **21752**

Crochet sup.
Upper looper
cod. **21754**

Crochet sup.
Upper looper
cod. **21756**

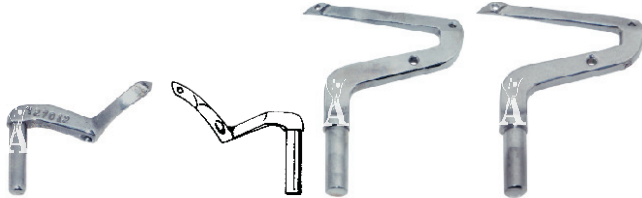

Crochet sup.
Upper looper
cod. **27012**

Crochet sup.
Upper looper
cod. **27013**

Crochet inf.
Lower looper
cod. **21701**
(= 20347 - 21137)

Crochet inf.
Lower looper
cod. **21757**



Crochet cat.
Chain looper
cod. **20378**
(= 25046)



Crochet cat.
Chain looper
cod. **20577**

KI. VF2200, VF2300, DV1400, DW1500, VF1400, VF1500, VF2400 serie, VF2500 serie

(MACCHINE PIANE - FLAT BED MACHINES)

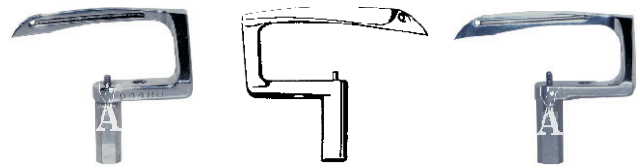

Crochet looper
cod. **94480**
(= 93310)

Crochet looper
cod. **95499**

Crochet looper
cod. **3209311**
(= 95174)

KI. VC VS2600 serie, VC VE VG VS2700 serie, VC2840 serie, VC3600 serie, VC3700 serie, VC3800 serie,

(MACCHINE A BRACCIO - FREE ARM MACHINES)

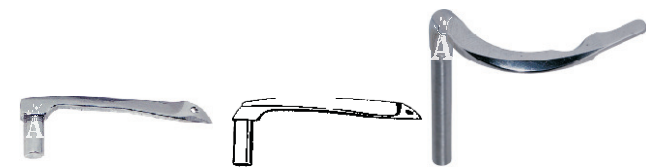

Crochet looper
cod. **3109300**

Crochet looper
cod. **3109305**

Crochet looper
cod. **3109310**

KI. AZ8400



Crochet sup.
Upper looper
cod. **2119301**

Crochet sup.
Upper looper
cod. **2119302**

Crochet sup.
Upper looper
cod. **2119303**

Crochet sup.
Upper looper
cod. **2119322**



Crochet sup.
Upper looper
cod. **2119323**

Crochet inf.
Lower looper
cod. **2119305**

Crochet inf.
Lower looper
cod. **2119324**

KI. CB-201, CB-501



Crochet looper
cod. **85168**

KI. FD-62



Crochet looper
cod. **68217**

KI. DCY100, DCZ100



Crochet sup.
Upper looper
cod. **37301**

Crochet inf.
Lower looper
cod. **37302**

KI. VM1802, VM1804



Crochet looper
cod. **66601**

KI. CM-263, CM-268, CM-364



Crochet looper
cod. **80413**

KI. DT30



Crochet looper
cod. **69084**

Crochet looper
cod. **69085**

Crochet looper
cod. **69086**

KI. DCZ200 serie, DCZ300 serie, DCZ428, DCZ500 serie, DCZ341, Z610, Z612



Coltello sup.
Upper knife
cod. **32914**



Coltello sup.
Upper knife
cod. **35286**
(=35211)



Coltello sup.
Upper knife
cod. **38332**



Coltello sup.
Upper knife
cod. **38332/12**



Coltello sup.
Upper knife
cod. **37514**



Coltello sup.
Upper knife
cod. **37514/11**



Coltello sup.
Upper knife
cod. **35897**



Coltello sup.
Upper knife
cod. **35897/11**



Coltello inf.
Lower knife
cod. **30421**



Coltello inf.
Lower knife
cod. **30421/11**



Coltello inf.
Lower knife
cod. **35285**



Coltello inf.
Lower knife
cod. **37538**



Coltello inf.
Lower knife
cod. **37538/11**



Coltello
Knife
cod. **32706**

KI. Z3000, Z5000, Z6000 serie, AZ6000, AZ6500 serie, AZ8000, AZ8500, AZ8600 serie,



Coltello sup.
Upper knife
cod. **20491**



Coltello sup.
Upper knife
cod. **20491/11**

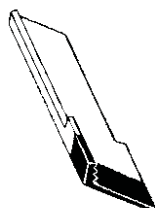

Coltello sup.
Upper knife
cod. **20491G**

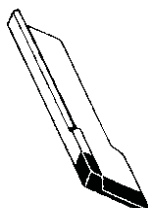

Coltello sup.
Upper knife
cod. **2020003**



Coltello sup.
Upper knife
cod. **2121107**



Coltello sup.
Upper knife
cod. **20496**



Coltello sup.
Upper knife
cod. **23580**



Coltello sup.
Upper knife
cod. **2121235**



Coltello inf.
Lower knife
cod. **20498**



Coltello inf.
Lower knife
cod. **22195**



Coltello inf.
Lower knife
cod. **23582**



Coltello inf.
Lower knife
cod. **2100167**

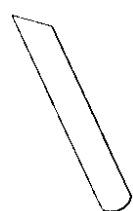

Coltello inf.
Lower knife
cod. **2101091**



Coltello inf.
Lower knife
cod. **2110305**



Coltello inf.
Lower knife
cod. **2121111**



Coltello
Knife
cod. **20271**

Coltelli per aspiracatenella verticale

Knives for vertical chain-off thread suction device

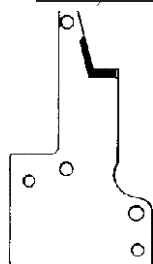

Controlama
Fixed knife
cod. **2111055**

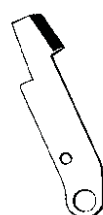

Coltello
Movable knife
cod. **2111056**

KI. DV1400 serie, DW1500



Coltello sup.
Upper knife
cod. **95276**

Coltello inf.
Lower knife
cod. **95277**

Coltelli per rasafilo pneumatico automatico
Knives for pneumatic automatic thread trimmer device



Coltello sup.
Upper knife
cod. **94417**

Coltello inf.
Lower knife
cod. **95399**

KI. VF1409, VF1509, VF2400 serie, VF2500 serie, VC2600 serie, VS2600 serie, VC2700 serie, VE2700 serie, VG2700 serie, VS2700 serie, VC2840 serie, VC3600 serie, VC3700 serie, VC3800 serie



Coltello sup.
Upper knife
cod. **95276**



Coltello sup.
Upper knife
cod. **3101028**



Coltello sup.
Upper knife
cod. **3101465**



Coltello sup.
Upper knife
cod. **3110037**

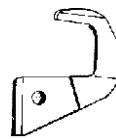

Coltello sup.
Upper knife
cod. **3120015**



Coltello sup.
Upper knife
cod. **3501032**



Coltello sup.
Upper knife
cod. **3501535**



Coltello inf.
Lower knife
cod. **3101026**

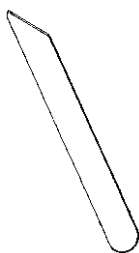

Coltello inf.
Lower knife
cod. **3101607**



Coltello inf.
Lower knife
cod. **3101633**



Coltello inf.
Lower knife
cod. **3110038**



Coltello inf.
Lower knife
cod. **3110038/11**

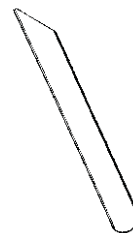

Coltello inf.
Lower knife
cod. **3120016**



Coltello inf.
Lower knife
cod. **3201062**

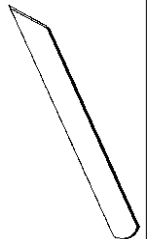

Coltello inf.
Lower knife
cod. **3501200**

Coltelli per rasafilo pneumatico automatico
Knives for pneumatic automatic thread trimmer device

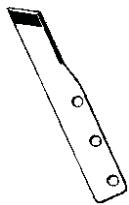

Coltello sup.
Upper knife
cod. **3120150**

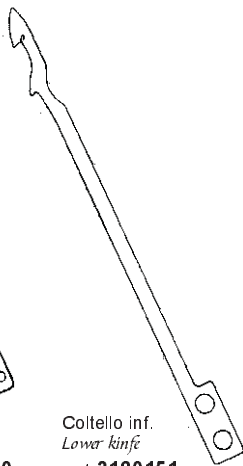

Coltello inf.
Lower knife
cod. **3120151**



Coltello sup.
Upper knife
cod. **3100512**



Coltello inf.
Lower knife
cod. **3100513**

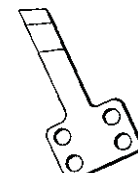

Coltello sup.
Upper knife
cod. **3101802**

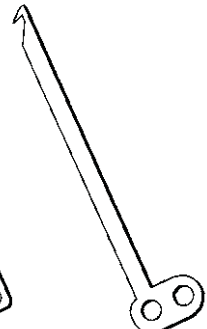

Coltello inf.
Lower knife
cod. **3101801**

KI. FD-62



Coltello sup.
Upper knife
cod. **68184**



Coltello sup.
Upper knife
cod. **68184/11**



Coltello inf.
Lower knife
cod. **68121**



Coltello inf.
Lower knife
cod. **68121/11**

KI. DCZ300 serie, DCZ500 serie, Z610

Morsetti ago
Needle clamps

KI. DCZ-361Y



Morsetto 2 aghi
Needle clamp (2 needles)
cod. **38011** (2,4 mm)

KI. DCZ-341-C, Z610



Morsetto 2 aghi
Needle clamp (2 needles)
cod. **35245** (5 mm)

KI. DCZ-365-C

Morsetto 2 aghi
Needle clamp (2 needles)
cod. **33247** (5 mm)

KI. DCZ-500 serie

KI. DCZ-520-W



Morsetto 2 aghi
Needle clamp (2 needles)
cod. **24132**

KI. DCZ-300 serie



Morsetto 2 aghi
Needle clamp (2 needles)
cod. **34927**

KI. DCZ-500 serie



Morsetto 2 aghi
Needle clamp (2 needles)
cod. **34914**



Barra ago
Needle bar
cod. **37372**

Barra ago
Needle bar
cod. **37122**

Dado ferma ago
Needle nut
cod. **62**

KI. AZ6000 serie, AZ8000 serie

Morsetti ago
Needle clamps

KI. AZ6000 serie

KI. AZ6500 serie

Morsetto 1 ago
Needle clamp (1 needle)
cod. **2129106**
(= 2109132)

Morsetto 2 aghi
Needle clamp (2 needles)
cod. **2109130** (2,4 mm)
cod. **2109131** (2,0 mm)

Morsetto 2 aghi
Needle clamp (2 needles)
cod. **2109187** (3,2 mm)
(= 2109120)
cod. **2109189** (5/6 mm)
(= 2109122)

KI. AZ8000 serie

KI. AZ8500 serie



Morsetto 1 ago
Needle clamp (1 needle)
cod. **2109100**

Morsetto 2 aghi
Needle clamp (2 needles)
cod. **2109101** (2,4 mm)
cod. **2109102** (2,0 mm)

Morsetto 2 aghi
Needle clamp (2 needles)
cod. **2109110** (3,2 mm)
cod. **2109183** (5/6 mm)
(= 2109112)

KI. DV1400, DW1500, VF1400, VF1500, VF2200, VF2300, VF2400 serie, VF2500 serie VC2600, VC2700, VC3600, VC3700

Morsetti ago
Needle clamps

Vite ago
Needle screw
cod. **1900**



Vite passafilo
Thread eyelet screw
cod. **1228**

Passafilo
Thread eyelet
cod. **93260**

Morsetto 2 aghi
Needle holder (2 needle)
cod. **93351** (= 93251)(3,2 mm)
cod. **93352** (= 93252)(4,0 mm)
cod. **93353** (= 93253)(4,8 mm)
cod. **93354** (= 93254)(5,6 mm)
cod. **93355** (= 93255)(6,4 mm)

Morsetto 3 aghi
Needle holder (3 needle)
cod. **93356** (= 93256)(4,8 mm)
cod. **93357** (= 93257)(5,6 mm)
cod. **93358** (= 93258)(6,4 mm)



Piastrina
Plate
cod. **36175**



Piastrina
Plate
cod. **32425**

Molla
Spring
cod. **32426**

Vite
Screw
cod. **1093**

Passafilo
Thread eyelet
cod. **93365**

Vite passafilo
Thread eyelet screw
cod. **1900**

KI. VF2400, VF2500

Vite ago
Needle screw
cod. **1892**

Vite passafilo
Thread eyelet screw
cod. **1230**

Passafilo
Thread eyelet
cod. **3200117**

Morsetto 2 aghi
Needle clamp (2 needle)
cod. **3209100** (3,2 mm)
cod. **3209101** (4,0 mm)
cod. **3209102** (4,8 mm)
cod. **3209103** (5,6 mm)
cod. **3209104** (6,4 mm)

Morsetto 3 aghi
Needle clamp (3 needle)
cod. **3209106** (4,8 mm)
cod. **3209107** (5,6 mm)
cod. **3209108** (6,4 mm)

Vite passafilo
Thread eyelet screw
cod. **1892**

Passafilo
Thread eyelet
cod. **3200046**



Chiave vite ago
Needle screw driver
cod. **37919**

KI. DCZ300 serie, DCZ500 serie, Z610, Z6000



Passafilo
Thread guide
cod. **23465**
(= 22556)

Passafilo
Thread guide
cod. **32968**

Passafilo
Thread guide
cod. **32423**

Passafilo
Thread guide
cod. **33167**



Passafilo
Thread guide
cod. **32358**

Passafilo
Thread guide
cod. **32955**

Passafilo
Thread guide
cod. **36233**
(= 32960)

Passafilo
Thread guide
cod. **32963**



Passafilo
Thread guide
cod. **34861**

Passafilo
Thread guide
cod. **34932**

Passafilo
Thread guide
cod. **36214**

Passafilo
Thread guide
cod. **34858**



Passafilo
Thread guide
cod. **32959**

Passafilo
Thread guide
cod. **34224**

Passafilo
Thread guide
cod. **34859**



Salva ago
Needle guard
cod. **24169**

Salva ago
Needle guard
cod. **32656**

Salva ago
Needle guard
cod. **33088**

Taglia catenella
Chain cutter
cod. **36632**



Bottone
Tension nut
cod. **34774**

Boccola
Bushing
cod. **33890**

Molla
Spring
cod. **30255**

Molla
Spring
cod. **32952**

Molla
Spring
cod. **32971**



Scodellino
Tension cap
cod. **37635**

Disco
Tension disc
cod. **31111**

Perno
Tension pin
cod. **6543**

Passafilo
Thread guide
cod. **33203**



Guida
Guide
cod. **33205**

Molla
Spring
cod. **32729**

Leva
Lever
cod. **26119**

Collare
Collar
cod. **32912**

KI. DCZ300 serie, DCZ500 serie, Z610

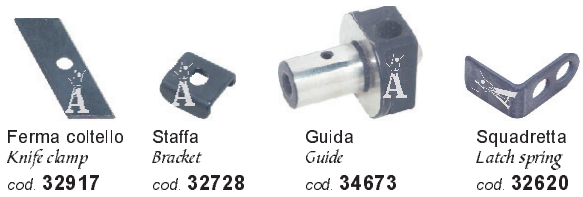

Ferma coltello
Knife clamp
cod. **32917**

Staffa
Bracket
cod. **32728**

Guida
Guide
cod. **34673**

Squadretta
Latch spring
cod. **32620**



Carter
Carter
cod. **35210**

Ingranaggio
Pump gear
cod. **30711**

Boccola
Bushing
cod. **32652**

Boccola
Bushing
cod. **32653**



Barra crochet
Looper bar
cod. **32800**

Leva
Lever
cod. **34508**

Guida
Guide
cod. **33751**



Guarnizione
Gasket
cod. **35283**

Guida
Guide
cod. **37966**

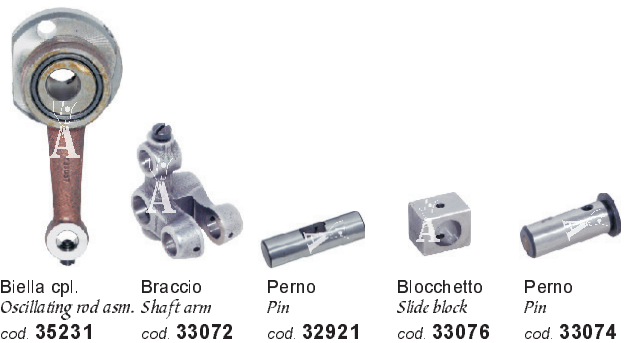

Biella cpl.
Oscillating rod asm.
cod. **35231**

Braccio
Shaft arm
cod. **33072**

Perno
Pin
cod. **32921**

Blocchetto
Slide block
cod. **33076**

Perno
Pin
cod. **33074**

KI. DV1400, DW1500



Eccentrico n° 6
Eccentric N° 6
cod. **34146**

KI. AZ6000, AZ8000



Salva ago
Needle guard
cod. **2109200**

Molla
Spring
cod. **2100187**